

Low Cost & Profile Frequency Rubidium Standard (LPFRS)

High Precision & Performance Source



Telecom | Navigation | Broadcast | Defense | Instrument

Applications

Table of Content :

- 1. INTRODUCTION.....3**
- 2. LPFRS SYSTEM DESCRIPTION.....3**
 - 2.1 PRINCIPLE OF OPERATION AND BASIC CONFIGURATION.....3**
 - 2.2 PHYSICS PACKAGE5**
 - 2.3 ELECTRONICS PACKAGE5**
 - 2.3.1 PRINCIPAL FUNCTIONS OF THE ELECTRONIC CIRCUITS5
- 3. LPFRS SPECIFICATIONS.....8**
- 4. LPFRS INSTALLATION AND OPERATION.....8**
 - 4.1 INTRODUCTION.....8**
 - 4.2 SHIPPING AND RECEIVING INFORMATION.....8**
 - 4.3 MOUNTING.....8**
 - 4.4 PIN FUNCTION LAYOUT.....10**
 - 4.5 NORMAL OPERATION.....10**
 - 4.5.1 ANALOG FREQUENCY ADJUSTMENT10
 - 4.6 SERIAL INTERFACE OPERATION.....10**
 - 4.6.1 INTRODUCTION10
 - 4.6.2 SERIAL INTERFACE CONNECTION11
 - 4.6.3 LPFRS INTERNAL PARAMETERS MONITORING11
 - 4.6.4 CENTRE FREQUENCY ADJUSTMENT WITH THE SERIAL INTERFACE12
 - 4.6.5 CENTRE FREQUENCY READ-BACK13
 - 4.7 LOCK MONITOR and XTAL MONITOR OUTPUTS.....13**
 - 4.7.1 TTL OR CMOS LEVEL 'LOCK MONITOR' GENERATION.....13
 - 4.7.2 DIRECT OPTICAL 'OUT OF LOCK' SIGNAL GENERATION.....13

1. INTRODUCTION

The Models LPFRS XX Rubidium Ultra-Stable Oscillators are sub-miniature, atomic resonance-controlled oscillators that provide an extremely stable frequency of 5, 10 or 20 MHz (sinusoidal). The LPFRS is designed for navigation, communication and timing instruments requiring such extremely stable and precise frequency. This manual contains information about the operation and field maintenance of the LPFRS.

Chapter 2 contains a general description of the unit. It also presents a basic theory of operation for a technician or engineer who requires a better understanding of the unit's operation.

Chapter 3 lists all specifications and operation requirements of the LPFRS.

Chapter 4 gives information on how to install and operate the unit. It is recommended that these chapters be read prior to operate the unit. This chapter describes also the possible interface connection for the monitoring of the internal parameters and for the centre frequency adjustment.

2. LPFRS SYSTEM DESCRIPTION

2.1 PRINCIPLE OF OPERATION AND BASIC CONFIGURATION

The LPFRS essentially consists of a voltage-controlled crystal oscillator (VCXO) which is locked to a highly stable atomic transition in the ground state of the Rb87 isotope. While the frequency of the VCXO is at the convenient standard frequency of 10 MHz, the Rb clock frequency is at 6.834XXX GHz in the microwave range. The link between the two frequencies is done through a phase-stabilized frequency multiplication scheme whereby a synthesized frequency is admixed to enable exact matching.

The Rb atoms are confined in a vapor cell at an elevated temperature. The cell is placed in a microwave resonator to which the microwave power derived from the VCXO is coupled. The Rb87 atoms in the cell occur with equal probability in the two hyperfine energy levels of the ground state ($F=1$ and $F=2$).

In order to detect the clock transition between these two levels, the atoms need to be manipulated in such a way that most of them occur in only one level. This is done by optical pumping via a higher lying state (P). Fig. 2-1 visualizes the atomic energy levels and transitions involved in the optical pumping process.

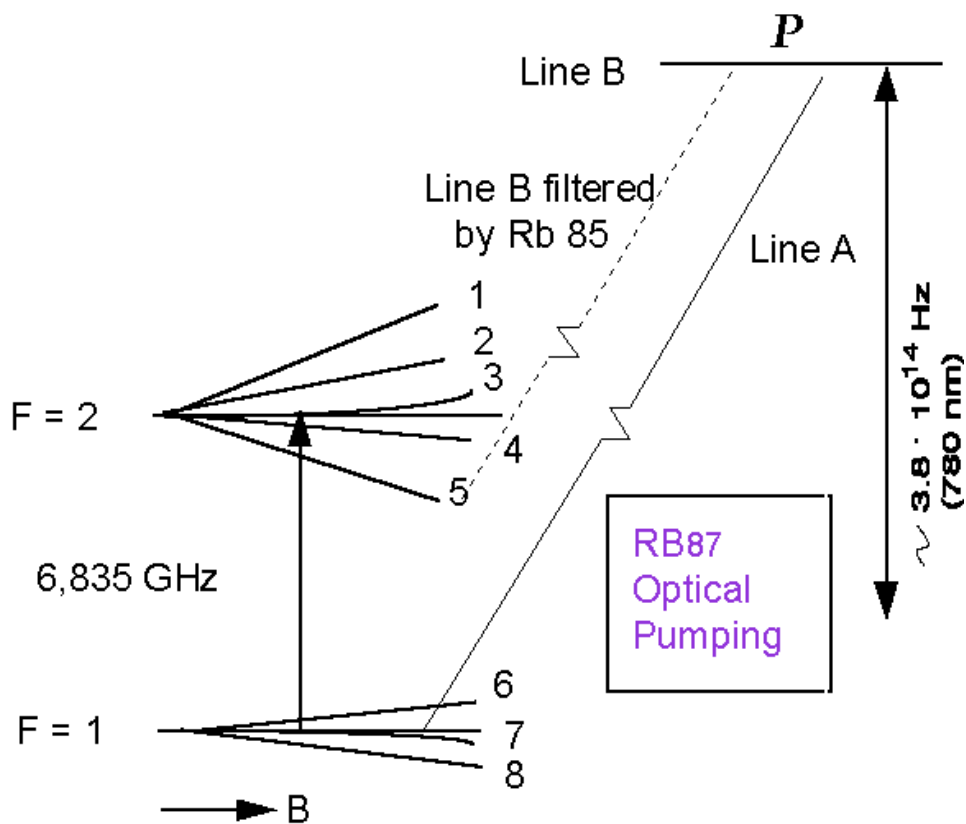

Fig. 2-1: Energy levels and transitions in Rb87 atoms during LPFRS operation

The pump light comes from a Rb resonance lamp which emits the light of Rb87 atoms. This light, which intersects the absorption cell, is filtered in such a way that mainly one optical frequency, which corresponds to a transition out of one of the two ground state levels (line A), enters the principal absorption region. The pump light excites Rb87 atoms which are in the lower hyperfine level (F=1) to the short-lived excited state P from which they decay to the two ground state levels (F=1,2) with equal probability. Since pumping occurs continuously out of the F=1 level, after some time, almost all atoms are found in the F=2 level and no further absorption occurs.

The transmitted light level is detected by a photodiode after the cell. If now a microwave field resonant with clock transition $F=2 \leftrightarrow F=1$ is coupled to the interaction region, the level F=1 is repopulated and light absorption is enhanced. A sweep of the microwave field over the resonance is detected as a small dip in the transmitted light level after the cell.

This signal is fed into a synchronous detector whose output generates an error signal which corrects the frequency of the VCXO when its multiplied frequency drifts off the atomic resonance maximum.

The absorption cell is filled with metallic vapor which contains Rb85 and Rb87 isotopes and a buffer gas. Filtering of the pump light is achieved in the entrance region of the cell by absorption with Rb85 atoms which have an accidental overlap with one of the Rb87 resonance transitions (line B): integrated filter cell.

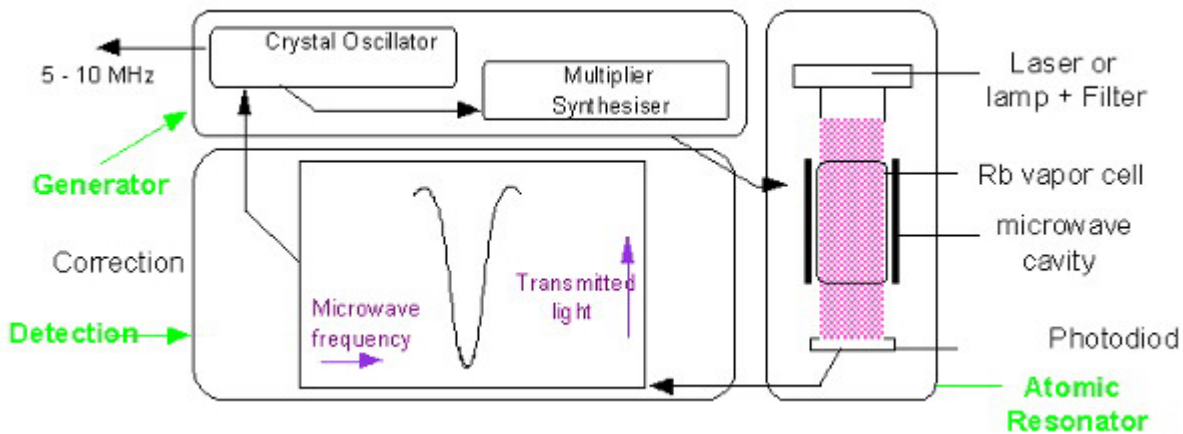

Fig. 2-2: Rubidium atomic clock principal block diagram

The principal function of the buffer gas is to keep the Rb atoms away from the cell walls and restrict their movements. As a result they are practically "frozen in place" for the interaction time with the microwave field. In this way the Doppler-effect is virtually removed and a narrow line width results.

The cell region is also surrounded by a so-called C-field coil which generates a small axial static magnetic field to resolve the Zeeman sub-transitions of the hyperfine line and select the clock transition, i.e. the one with the least magnetic sensitivity. To further reduce the magnetic sensitivity, the complete physics package is placed into nested magnetic shields.

Fig. 2-2 gives a basic overview of the different function blocks of the Rubidium atomic clock. The LPFRS consists of three different packages. The optical elements, which include the Rb absorption cell and microwave cavity, form the atomic resonator, while the electronics package is constituted of the generator and the detection circuitry.

2.2 PHYSICS PACKAGE

The main design characteristics of the physics package are its low power consumption, small size and mass, along with minimal environmental sensitivities and mechanical ruggedness.

All parts of the physics package are incorporated in a aluminium tube surrounded by magnetic shields. Inside this tube, lamp and cell sections form two separate blocks which operate at well-defined but different temperatures. The cylindrical tube is filled with polyurethane foam for low thermal conductivity. The lamp and cell sections are separated with a glass window. This configuration greatly reduces the thermal flow between the blocks and the tube envelope. It allows a very compact design with low power consumption, short warm-up time and minimal environmental sensitivities.

Other design features which contribute to the compact design are:

- use of the integrated filter technique (IFT)
- use of a magnetron-type microwave resonator

The integrated filter technique which combines the optical filtering and pumping in one cell contributes also to the reliability since the configuration is simplified and the number of components reduced. The thermal capacitance of the cell assembly is relatively low. As a consequence, the necessary power during warm-up is greatly reduced.

The magnetron resonator is a cylindrical cavity loaded with a concentric capacitive-inductive structure (annular metal electrodes). It allows smaller cavity dimensions and concentrates the microwave field at the right region of the cell.

The Rb lamp is an electrode-less RF-discharge lamp: a heated glass bulb which contains Rb and a starter gas surrounded by an RF-coil.

Although the atomic clock transition frequency is inherently quite stable, there are second order influences which affect the frequency, i.e. temperature (buffer gas), light intensity (light shift = optical Stark effect), magnetic field (2nd order Zeeman effect). As a consequence, the temperatures of lamp and cell, the power of the lamp oscillator and the current in the C-field coil have to be carefully stabilized.

2.3 ELECTRONICS PACKAGE

2.3.1 PRINCIPAL FUNCTIONS OF THE ELECTRONIC CIRCUITS

The clock transition of a Rb resonator is a microwave transition at 6.834 .. GHz.

The microwave resonance occurs as a dip in the optical signal; i.e. in the Rb lamp light which, after transiting the cell, is detected by a photodiode.

The basic purpose of the electronics package is to synchronize the ingoing microwave frequency, derived from a quartz crystal oscillator, to this absorption dip. This is achieved by tuning the microwave frequency to maximum optical absorption.

Frequency variations of the microwave signal are transformed into DC current changes at the photodetector. The dip, visualized in the photocurrent versus microwave frequency curve of Fig. 2-3, is very small: on the order of 1% of the total photocurrent which is however approximately 10 times higher compared to other commercial rubidium standards on the market.

Since DC detection of the dip is not feasible , an AC detection method is used for the following reasons:

- The dip amplitude is very small compared to the total photocurrent.
- The slope of the derivative of the dip photocurrent versus microwave frequency corresponds to roughly 1 nA/Hz. AC detection is the only solution to have a good signal/noise ratio since the photo-detector with associated amplifier are affected by flicker noise.

The AC method involves square wave frequency modulation of the microwave signal at a rate of fm~330 Hz. As shown in Figure 2-3 the modulated microwave frequency flips between 2 discrete frequency values f1 et f2. The resulting photo- current i(t) appears then also (after the transient)at 2 discrete values i1 and i2 .

The difference between i1 and i2 produces the error signal used for the quartz crystal center frequency adjustment until the mean value of f1 and f2 is exactly equal to the rubidium hyperfine frequency.

The clock microwave frequency of the Rb atoms in the vapor cell has a nominal value of 6834.684 MHz . This frequency is generated from a voltage controlled quartz oscillator (VCXO) which is multiplied up to 90 MHz .

Multiplication from 90 MHz to 6840 MHz is accomplished in one stage (x76) using a step-recovery diode mounted in the magnetron resonator inside the physics package.

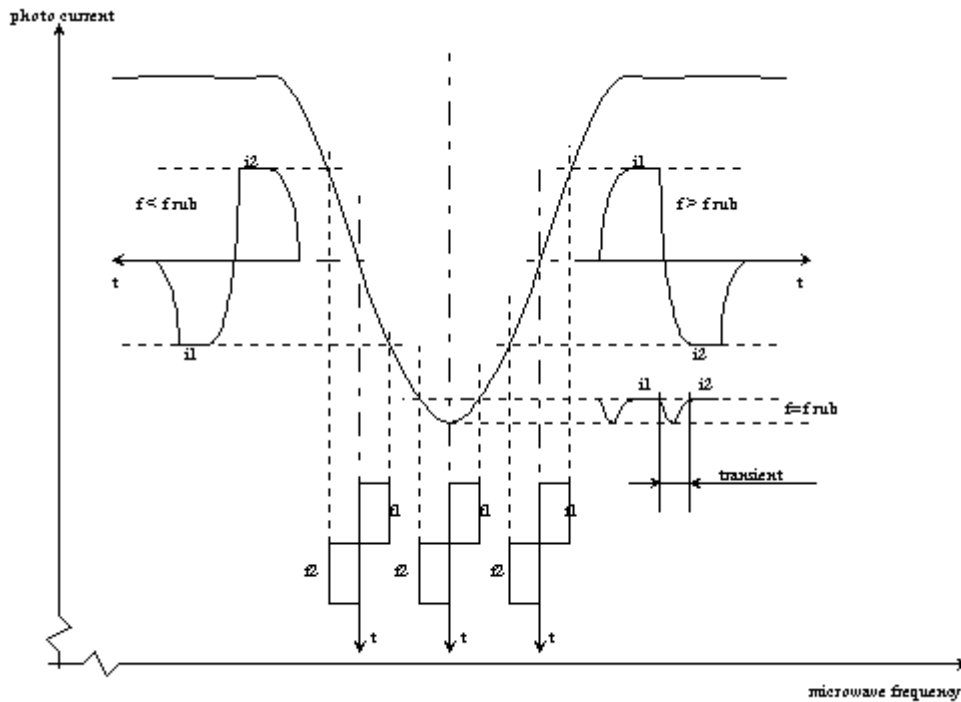

Fig. 2-3: Dip minimum detection

The 5.316... MHz phase modulation is introduced at the 90 MHz level. The 5.316... MHz spectrum is thus reproduced as a sideband of the 6840 MHz signal multiplied from the 20 MHz VCXO. The difference of the two frequencies corresponds to the Rb clock frequency.

This 5.316... MHz is generated by a synthesizer which is frequency modulated at the rate of fm for dip detection.

The center frequency of the synthesizer is adjustable with step sizes of 12mHz in order to have the capability to adjust the LPFRS output frequency (10 MHz) with a resolution of 1×10^{-9} per step and, also, to compensate the frequency shift due to the buffer gas pressure inaccuracies in the cell.

The Rb light is generated by a plasma discharge in the Rb lamp. This is sustained by an RF oscillator which drives a coil surrounding the Rb lamp bulb. In addition, the lamp is heated to 140°C and stabilized within 0.2°C over the full operating temperature range. The temperature controlled heating power is generated by a wound resistive heater wire. Another part of the heating power is generated by the RF oscillator.

The Rb absorption cell is heated to ~85°C and also stabilized within 0.3°C over the full operating temperature range. The heating by a heater wire and the temperature control follows the same pattern as for the lamp heater.

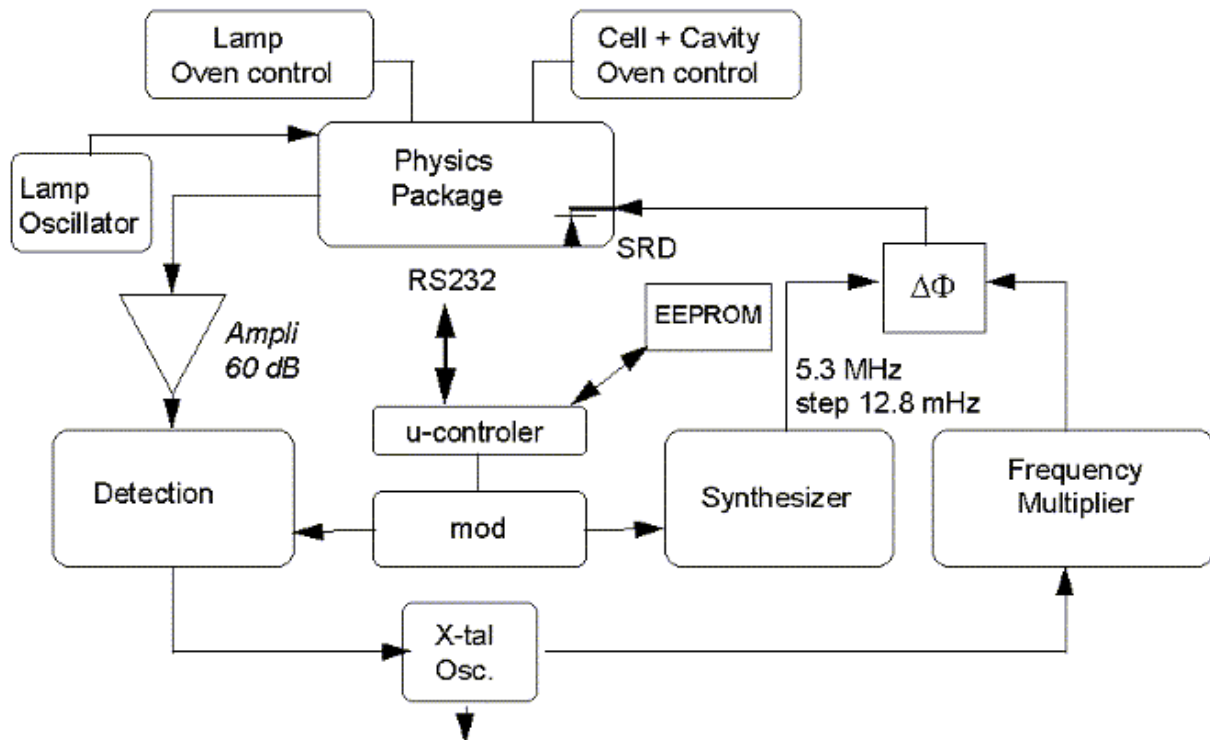

Fig. 2-4: LPFRS block diagram

The C-field coil within the physics package generates a magnetic field necessary for Rb spectral lines separation. This magnetic field allows fine tuning of the 10MHz output frequency by shifting the Rb frequency hyperfine transition by the second-order Zeeman effect.

A high stability current generator drives this coil; it is adjustable by the user in order to attain a fine analog or numerical resolution via a digital-to-analog converter.

The user interface consists of the RS-232 port for the monitoring of the internal parameters and for the center frequency adjustment. In addition, an analog frequency control input is available to the user for center frequency adjustment by external potentiometer or external digital to analog converter.

The correct operation of the unit can be checked by a single open collector type output signal called ' lock monitor'. This lock monitor information is generated by the micro-controller and is a function of the following parameters:- Light level intensity

- Rb signal level (detected signal)
- Heaters supply voltages
- RF section health.

The different alarm threshold levels corresponding to the different internal LPFRS electronics and physics parameters are programmed during the automatic adjustment procedure at the factory.

The power section of the LPFRS consists of three dc-dc converters. One is used for generating the internal 5V needed by the logic circuitry, the two other converters are used for the lamp and the cell heaters. The synchronization of the three converters is achieved by the use of a common ramp generator given by an internal 125kHz signal derived by direct division of the 20 MHz main VCXO.

A detailed block diagram of the LPFRS is given by Fig. 2-4.

3. LPFRS SPECIFICATIONS

[follow this link](#)

4. LPFRS INSTALLATION AND OPERATION

4.1 INTRODUCTION

This chapter of the manual contains information regarding the installation and operation of the TNT Model LPFRS. It is recommended to read this chapter carefully prior to operate the unit.

4.2 SHIPPING AND RECEIVING INFORMATION

The LPFRS is packaged and shipped in a foam-lined box. The unit is inspected mechanically and electrically prior to shipment. Upon receipt of the unit, a thorough inspection should be made to ensure that no damage has occurred during shipping. If any damage is discovered, please contact

TEMEX NEUCHATEL TIME SA
PHONE: +41 32 732 16 66
FAX: +41 32 732 16 67
CH-2000 NEUCHATEL / SWITZERLAND

Should it be necessary to ship the unit back, the original case and packing should be used. If the original case is not available, a suitable container with foam-packing is recommended.

CAUTION

Care must be taken for the transportation of the LPFRS to ensure that the maximum acceleration due to a shocks 50g/ 11ms is not exceeded.

LPFRS contains glass bulbs, crystal resonators and crystal filters.

When LPFRS integrated into an instrument, such instrument shall be packed in a suitable container, similar to containers generally use for the transportation of instruments like scope, video display or computer.

4.3 MOUNTING

The unit should be mounted in preference to a PCB equipped with connection metallised holes of 1.2 to 1.5 mm diameter. Mounting screws (2 x M3, stainless steel 5mm maxi into the LPFRS box) should be tightened with a torque between 50 Ncm and 100 Ncm.

The heat transfer characteristics of the mounting surface must be adequate to limit the rise of the unit's base plate to <+65°C. Since the minimum total power consumption for proper Rb operation is around 200mA / 24V, the allowable environmental temperature (Tamax), for this mounting is:

$$T_{\text{amax}} = 65^{\circ}\text{C} - V_s \times I_s \times R_k$$

CAUTION

Care must be taken to ensure that the maximum operating temperature is not exceeded, (+65°C as measured at the unit's base plate)

This maximum temperature can be reached when operating the unit into forced air flow at 65°C or by mounting the unit into user equipment with thermal interface corresponding to a thermal resistance of 1 to 2 °C/W between the LPFRS unit and the ambient .

The LPFRS is a well shielded unit, using several magnetic shield layers as well as special RF shields for the RF section. Nevertheless, some consideration must be given to the operating location of the unit, regardless of its application. To minimise frequency offsets and/or non-harmonic distortion, the unit should not be installed near equipment generating strong magnetic fields such as generators, transformers, etc. The general information for the mechanical interface of the LPFRS unit is given in the package drawing of Fig. 4-4

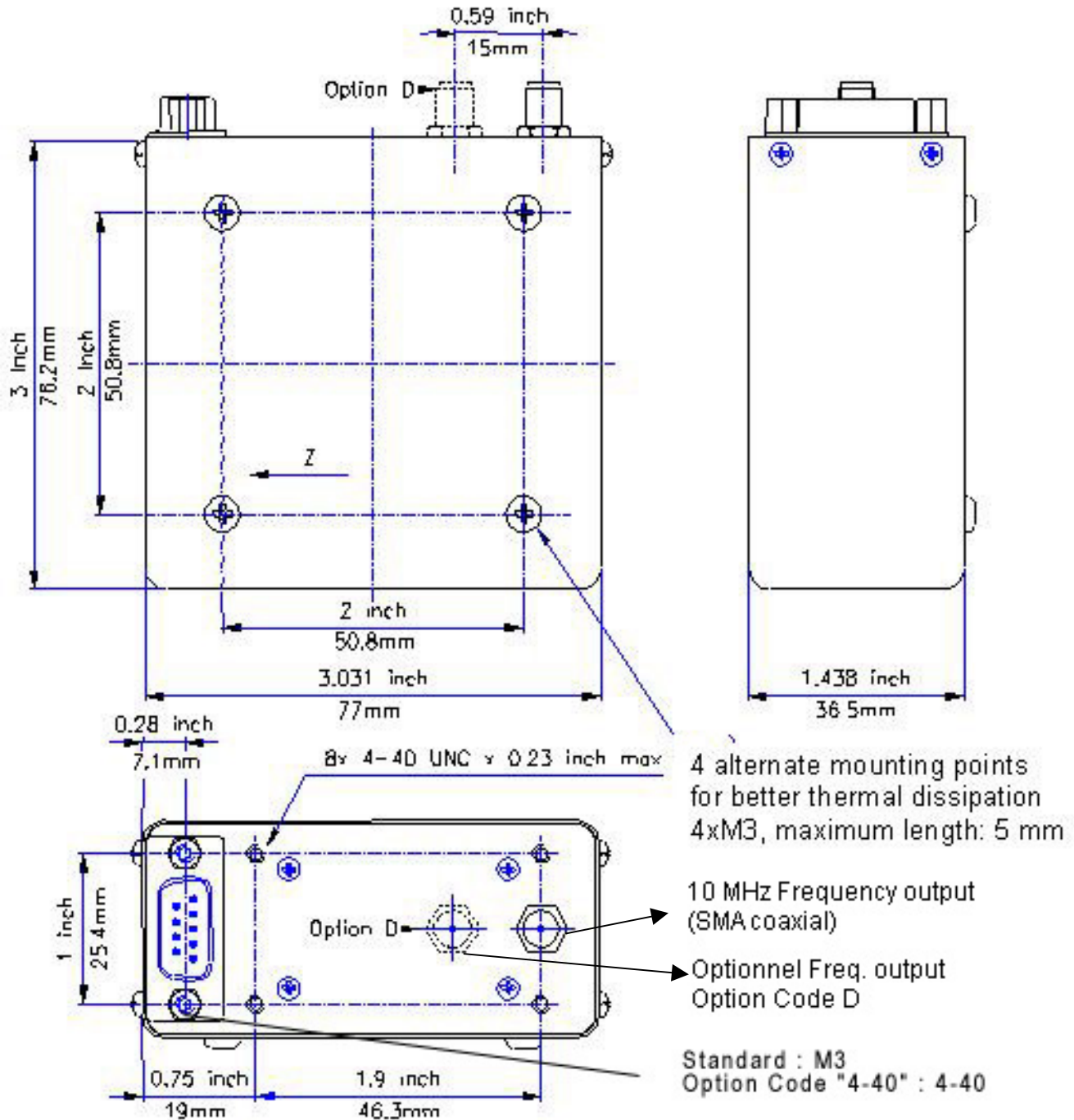

Fig. 4-4

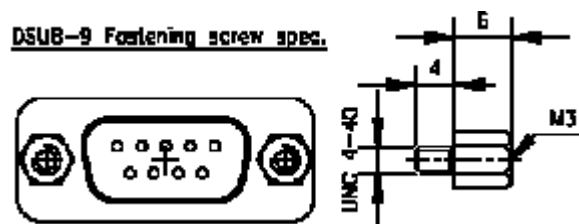
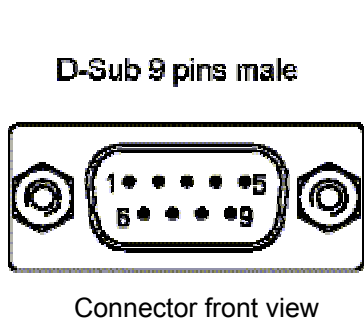

Fig. 4-5. Specification for the two fastening screws of the DSUB9 connector.

4.4 PIN FUNCTION LAYOUT

The complete pin layout is given in following figure:



PIN	FUNCTION
1	+24V (+12V)
2	0V (GND)
3	Lock indicator (open coll.)
4	Vref (5V hi-stability ref.)
5	GND
6	TxD (TTL) Transmit
7	GND
8	Frequency adjust (0 to 5V)
9	RxD (TTL) Receive

4.5 NORMAL OPERATION

When 12 Vdc (or 24V) is applied to pins 1 (+) and 5, 7 (-), the unit will immediately begin to generate a 10 MHz signal from the crystal oscillator. Within approximately 8 minutes (standard version) after application of input power the unit will "lock". Hence the crystal is now stabilised by the atomic resonant frequency.

The unit is able to provide a single signal called 'lock monitor' (pin 3) which toggles to high level when the internal crystal oscillator is locked to the Rb atomic resonance. (see chapter 4.7). The centre frequency can be adjusted by external potentiometer using the internal voltage reference (pin 4).

4.5.1 ANALOG FREQUENCY ADJUSTMENT

The LPFRS is equipped with an analog frequency adjustment circuit which provides center frequency adjustment by applying an external voltage of 0 to 5V on Pin 8.

This analog voltage can be generated with an external potentiometer connected to Vref indicator and GND (see pin function layout).

4.6 SERIAL INTERFACE OPERATION

4.6.1 INTRODUCTION

The LPFRS is equipped with a microcomputer, associated with multi-channel D/A converters, used for setting its parameters. This microcomputer is also used for the interrogation and detection of the Rb absorption 'dip'.

The built-in serial interface allows an automatic parameter adjustment during the manufacturing process as well as coarse and fine adjustment of the centre frequency.

All the working parameters are stored in a built-in EEPROM memory. In addition an 8 channel A/D converter is used for monitoring the main internal signals such as: light level, signal level, thermostats heating currents etc...

4.6.2 SERIAL INTERFACE CONNECTION

The data transfer from the LPFRS can be made by direct connection to a PC or standard terminal.
The data transfer parameters are the following:
bit rate: 1200 bits/s.

parity: none
start bit: 1
data bits: 8
stop bit: 1

IMPORTANT NOTE

In most cases, the serial PC interface accepts the 0 to 5V level and a direct connection can be made.

In case this 0 to 5V standard is not working , please refer to the small adaptation circuit called ' RS 232 adapter circuit' described in annex I.

4.6.3 LPFRS INTERNAL PARAMETERS MONITORING

The internal parameters monitoring is made via the serial interface and with the use of a single command 'M' followed by a carriage return character.

The LPFRS will respond to this single character command with an eight ASCII / HEX coded string which looks like:

HH GG FF EE DD CC BB AA <CR> (FF:not used)

Where each returned byte is an ASCII coded hexadecimal value, separated by a <Space> character.

All parameters are coded at full scale.

- **DC-Voltage of the photocell**

- HH: DC-Voltage of the photocell (0 to 5V for FF to 00)**

- This signal corresponds to the transmitted Rb light level.

- This is the light of the Rb lamp which is partly absorbed by the Rb cell.

- The nominal photocell voltage is in the range 2.0 to 3.5 V but must stay stable after the warm-up time.

- The photo cell voltage is related to the internal reference 5 V voltage.

- The full scale corresponds to the coded value '00' and the zero (no light) corresponds to the coded value 'FF'

- **Rb signal level**

- GG: Peak voltage of Rb signal level (0 to 5V for 00 to FF)**

- This signal monitors the rectified value of the AC signal produced by the interrogation process of the Rb dip absorption .

- During warm-up time this signal is approximately 0V and after it stabilises to a nominal value of 1 to 3.3V.As long as this signal is too low (<0.6V) the internal LPFRS control unit sweeps the Xtal frequency in order to find the Rb absorption dip.

- **Varactor control voltage (VCXO control)**

EE: VCXO control voltage (0 to 5V for 00 to FF)

This parameter corresponds to the voltage applied to the varicap of the internal VCXO. In normal operation this voltage is mainly temperature dependent in the range 2 to 3.5V in order to compensate the frequency versus temperature characteristic of the crystal resonator. During warm-up the control unit generates a ramp of this parameter from 0.3 to 5V and from 5V to 0.3V until the Rb dip absorption is found.

- **Frequency adjustment voltage**

DD: o/p frequency adj. voltage (0 to 5V for 00 to FF)

This parameter corresponds to the frequency adjustment voltage provided by the user . This information can be used for a read-back of the actual voltage applied to pin 8 of the LPFRS connector.

- **Rb lamp heating limiting current**

CC: Rb lamp heating limiting current (500mA to 0mA for 00 to FF)

This parameter corresponds to heating limiting current applied to the lamp heating resistive element. In normal operation, this current depends on the ambient temperature but should stay between 1A and E6. During warm-up, this current is set to its maximal value 00h (no current limiting).

- **Rb cell heating limiting current**

BB: Rb cell heating limiting current (500mA to 0mA for 00 to FF)

This parameter corresponds to heating limiting current applied to the cell heating resistive element. In normal operation, this current depends on the ambient temperature but should stay between 1A and E6. During warm-up, this current is set to its maximal value 00h (no current limiting).

- **90 MHz power control**

AA: 90 MHz power control signal (0 to 5V for 00 to FF)

This parameter corresponds to the automatic gain control loop used for the stabilisation of the interrogation signal applied into the Rb cell microwave cavity. In normal operation, this voltage must stay stable within the 2 to 4.5 V range and is mainly ambient temperature dependent in a range of less than $\pm 20\%$ for the full temperature range.

4.6.4 CENTRE FREQUENCY ADJUSTMENT WITH THE SERIAL INTERFACE

Two single character commands are available to the user for centre frequency adjustment. This correction (coarse or fine) is automatically loaded into the internal EEPROM memory and becomes permanent .

Cxx<CR>: Coarse output frequency correction through the synthesiser, by steps of 1×10^{-9} where xx is a signed 8 bits word (HEX coded).

Example:

'C7F<CR>' will produce $+1.27 \times 10^{-7}$ frequency correction from the nominal value 0

'CFF<CR>' will produce -1×10^{-9}

'C00<CR>' return to the nominal value (factory setting)

'C80<CR>' will produce -1.28×10^{-7} freq. correction from nominal value 0

Fxx<CR>: Fine output frequency correction through C-field, by steps of 1×10^{-11} where xx is a signed 8 bits word(HEX coded).

Example:

'F7F<CR>' : $+1.27 \times 10^{-9} \pm 20\%$ frequency correction from the nominal value 0

'FFF<CR>' : $-1 \times 10^{-11} \pm 20\%$ compared to F00.

'F00<CR>' return to the nominal value 0

'F80<CR>' $-1.28 \times 10^{-9} \pm 20\%$ frequency correction from nominal value 0

Please note that fine frequency correction is used at factory to set the LPFRS to the nominal frequency before delivery.

4.6.5 CENTRE FREQUENCY READ-BACK

Coarse and fine frequency corrections value can be read back by the following commands:

L06 <CR> for coarse adjustment

L0A <CR> for fine adjustment

4.7 LOCK MONITOR and XTAL MONITOR OUTPUTS

The LPFRS contains a 'lock monitor' function which consist in a monitoring of the internal parameters like light level, Rb absorption 'dip' level, heaters monitoring etc.. and a comparison with nominal values. This principle of operation ensures the user that the LPFRS VCXO is still locked correctly onto the Rb atoms resonance. The 'lock monitor' output circuitry looks like an open collector output with some differences as shown by the two following diagrams:

4.7.1 TTL OR CMOS LEVEL 'LOCK MONITOR' GENERATION

The lock monitor output can be directly connected to the CMOS load, or a pull-up resistor can be added for TTL compatibility.

4.7.2 DIRECT OPTICAL 'OUT OF LOCK' SIGNAL GENERATION

LED device can be directly connected to the 'lock monitor output' according to the following:

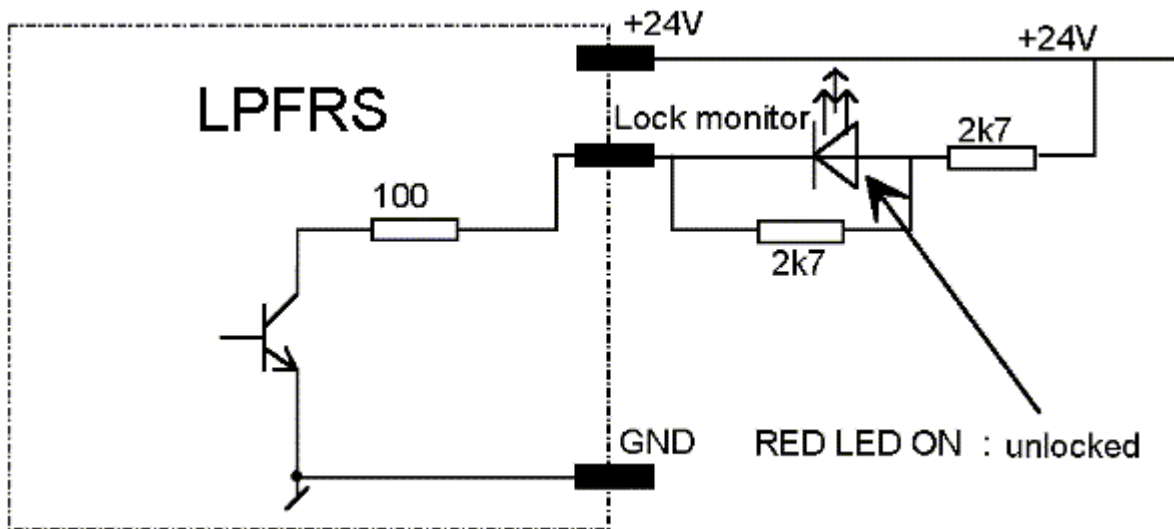

The lock monitor output can be directly connected to the CMOS load, or a pull-up resistor can be added for TTL compatibility.